

1

Kit 145104

NISSAN Altima, 4-dr Sedan, 13-18



ISO 11154-E

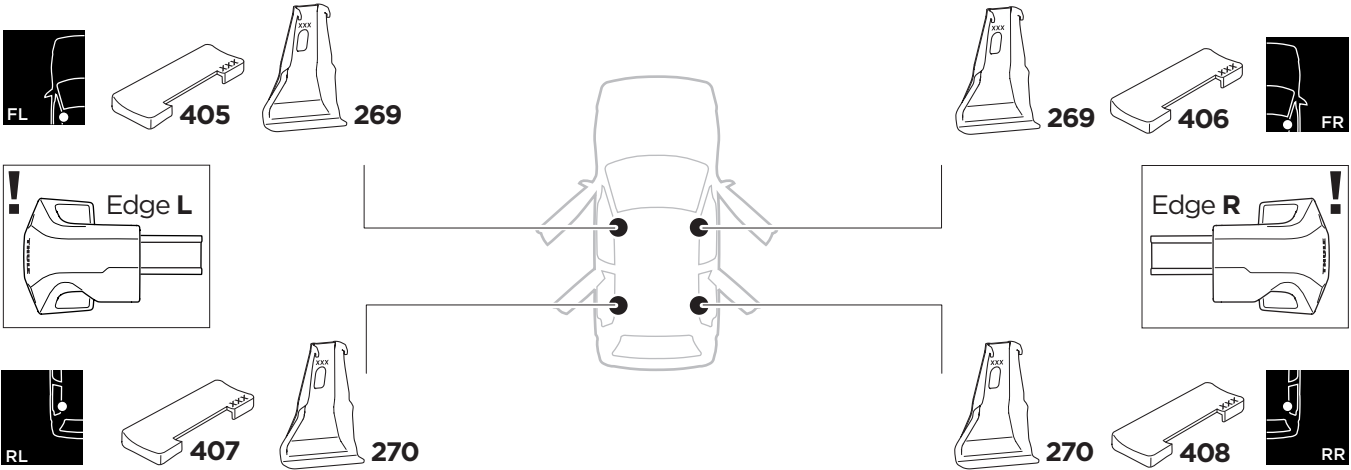
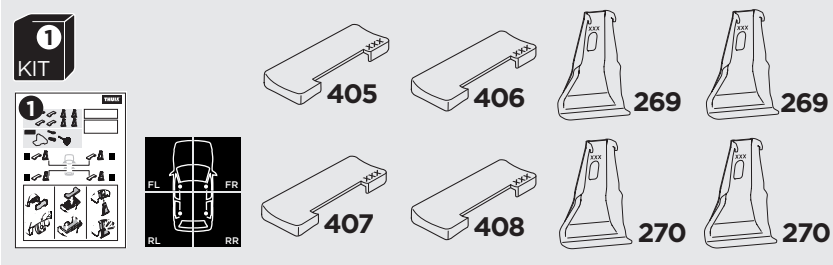



THULE WingBar Evo	THULE WingBar Edge	THULE WingBar	THULE SquareBar	Evo X (scale)	Edge X (scale)
NISSAN Altima, 4-dr Sedan, 13-18				42,5	L

THULE ProBar	THULE SlideBar	X (mm/inch)		
NISSAN Altima, 4-dr Sedan, 13-18		1076 mm / 42 ³ / ₈ "		



THULE WingBar Evo	THULE WingBar Edge	THULE WingBar	THULE SquareBar	Evo Y (scale)	Edge Y (scale)
NISSAN Altima, 4-dr Sedan, 13-18				38,5	B

THULE ProBar	THULE SlideBar	Y (mm/inch)		
NISSAN Altima, 4-dr Sedan, 13-18		1036 mm / 40 ³ / ₄ "		

	W (mm/inch)	Z (mm/inch)
NISSAN Altima, 4-dr Sedan, 13-18	650 mm / 25 ⁵ / ₈ "	265 mm / 10 ³ / ₈ "

