

# Kit 1489

VOLKSWAGEN Touran, 5-dr MPV, 03- (CHINA)\*

\* Without railing

480R  
754

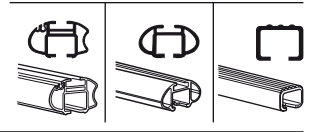
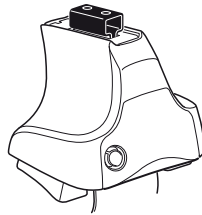

480

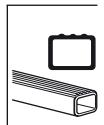
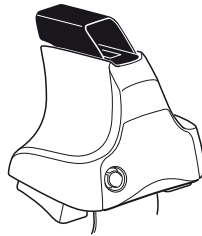

750

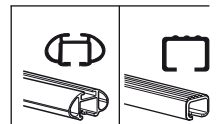
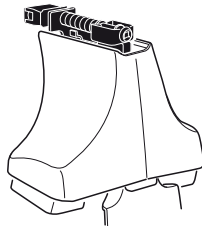

**Kit**



**3**

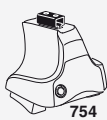

754

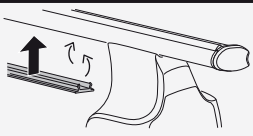
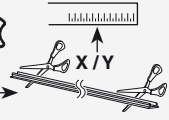

750



**1**

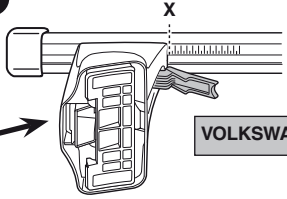

**2**



<b>VOLKSWAGEN Touran, 5-dr MPV, 03- (CHINA)</b>	<b>X</b>
	<b>46</b>



**1**

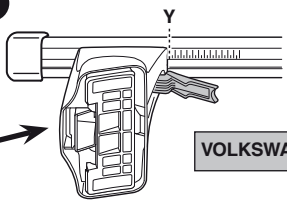

**2**



<b>VOLKSWAGEN Touran, 5-dr MPV, 03- (CHINA)</b>	<b>Y</b>
	<b>42,5</b>



480R



480

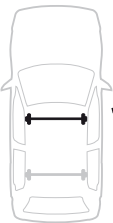

**1**

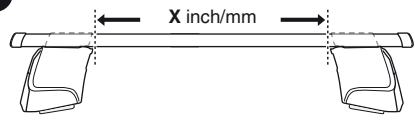

**2**



<b>VOLKSWAGEN Touran, 5-dr MPV, 03- (CHINA)</b>	<b>X inch</b>	<b>X mm</b>
	<b>43 3/4"</b>	<b>1111 mm</b>



**1**

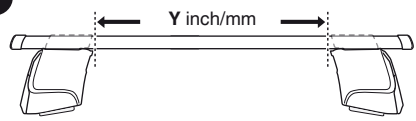

**2**



<b>VOLKSWAGEN Touran, 5-dr MPV, 03- (CHINA)</b>	<b>Y inch</b>	<b>Y mm</b>
	<b>42 3/8"</b>	<b>1076 mm</b>

4

VOLKSWAGEN Touran, 5-dr MPV, 03- (CHINA)

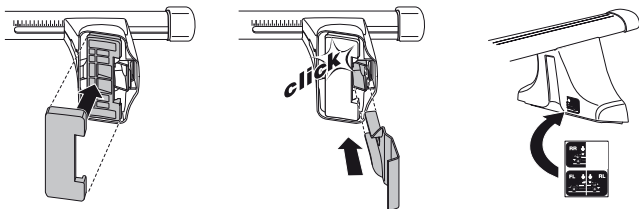
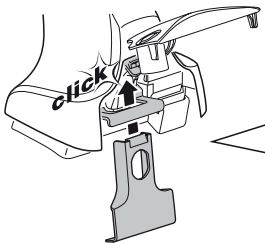
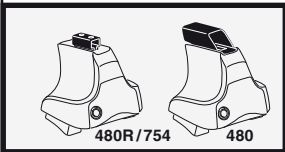
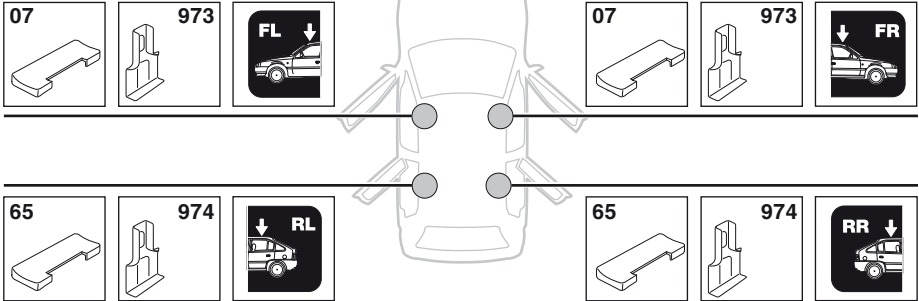

5

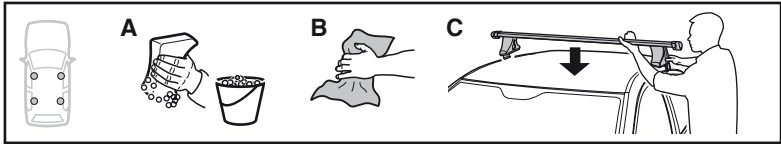

	X mm	Y mm	X inch	Y inch
<b>VOLKSWAGEN Touran, 5-dr MPV, 03- (CHINA)</b>	<b>400 mm</b>	<b>770 mm</b>	<b>15 <sup>3</sup>/<sub>4</sub> "</b>	<b>30 <sup>3</sup>/<sub>8</sub> "</b>

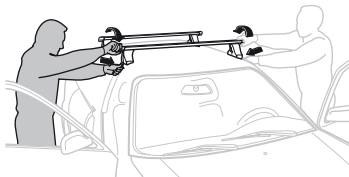
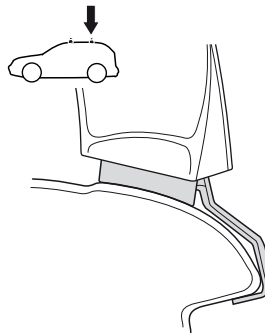
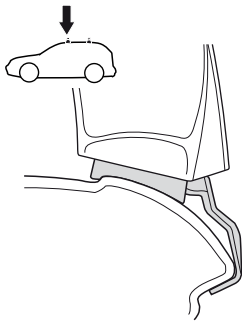
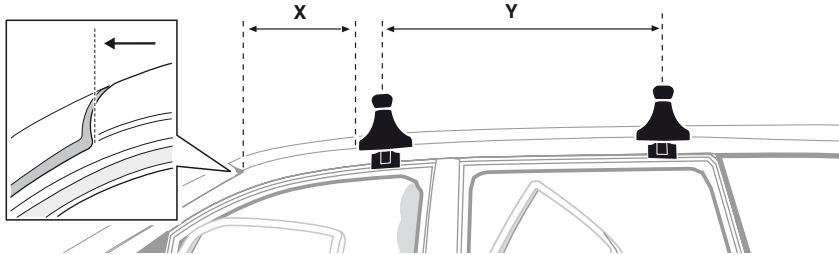

**GB/US** Tighten alternately

**D** Die Schrauben abwechselnd anziehen

**F** Serrer alternativement chaque côté

**NL** Afwisselend aan de linker- en de rechterkant aandraaien

**I** Alternare il serraggio delle viti

**E** Apertar alternativamente

**PT** Aperte alternadamente

**S** Dra åt växelvis

**FIN** Kierrä vuorotellen

**EST** Pinguldage vaheldumisi

**LAT** Pielieciet pamišus

**LIT** Užsukinėkite pakaitomis

**PL** Śruby dokręcaj naprzemiennie

**RU** Затягивайте попеременно

**CZ** Pokręťta bagažníka dokręcaj dokręcaj naprzemiennie.

**SK** Doťahujte striedavo

**SLO** Privijajte izmenično.

**HR** Naizmjenično zategnite

**HU** Egymástól függetlenül szorítandó

**GR** Σφιγγετε εναλλάξ

**TR** Dönüşümlü sıkın

**中文** 交替拧紧

**한국어** 번갈아 가며 조이십시오.

**日本語** 交互に締め付けてください。

**ไทย** ชั้้นโน้แบบสลับ

6



480R/754



480

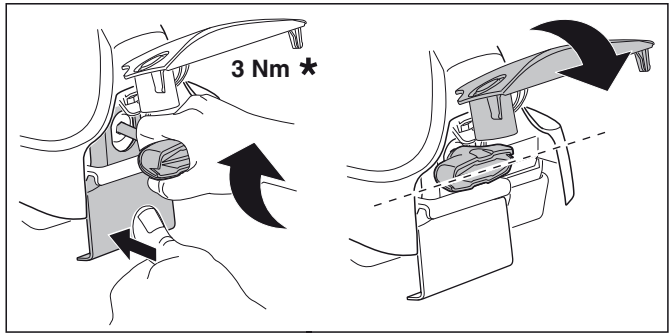

3 Nm \*

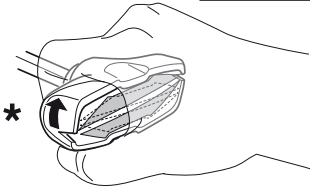

\*

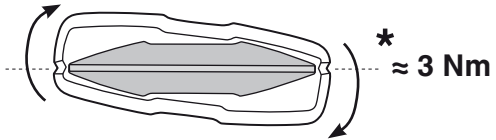

\* ≈ 3 Nm



750

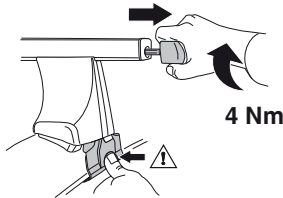

4 Nm

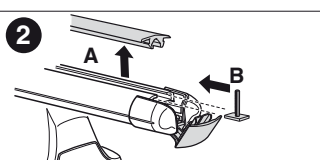
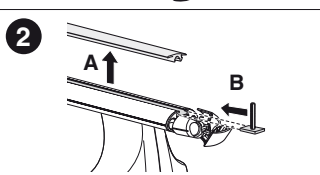
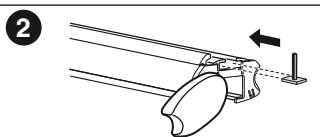
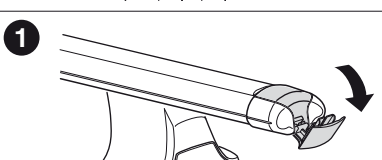
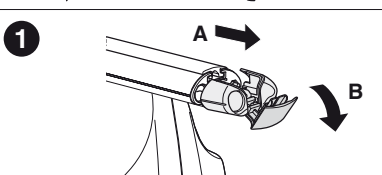
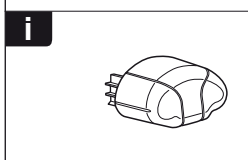
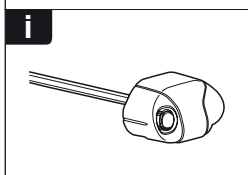
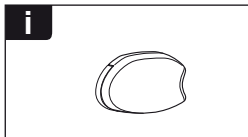
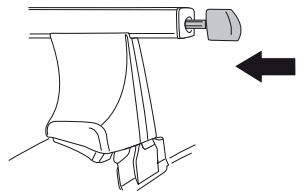



**THULE**  
SWEDEN  
**ONE  
KEY  
SYSTEM**



		(x4)
		(x6)
		(x8)
NA		(x10)
EUR		(x12)
ASIA		(x12)



WW ▶ Thule Sweden AB, Box 69, 330 33 Hillerstorp, SWEDEN  
NA ▶ Thule Inc., 42 Silvermine Road, Seymour, Connecticut 06483, USA

info@thule.com  
customer.service@thule.com

www.thule.com