

# Kit 1196

PEUGEOT 607, 4-dr Sedan, 00-

480R  
754

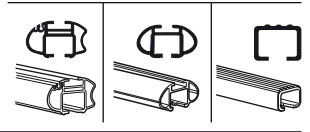
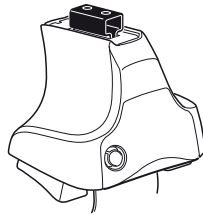

480

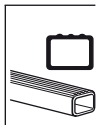
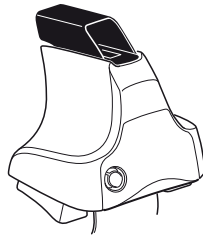

750

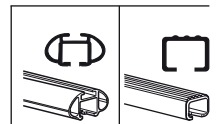
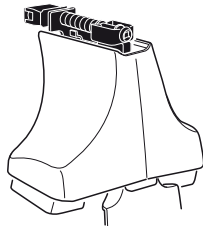

**Kit**

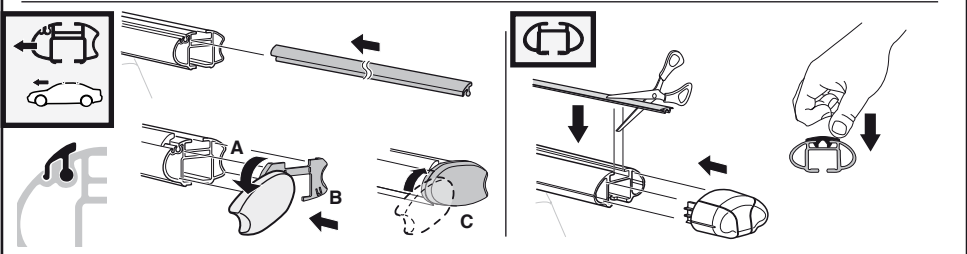
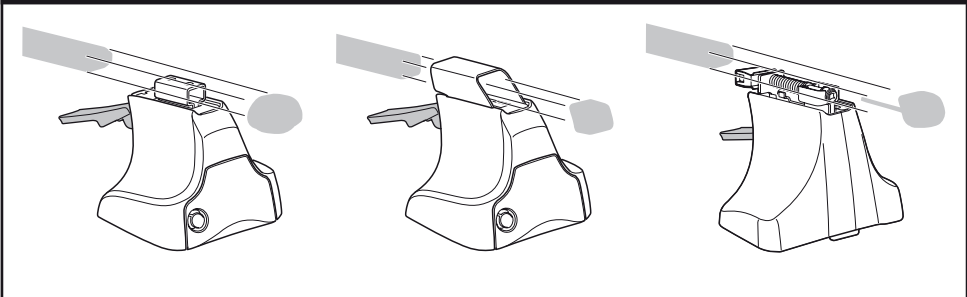

3

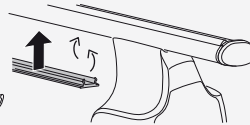
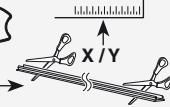
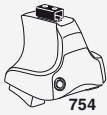

1

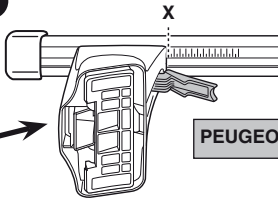
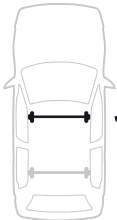

2

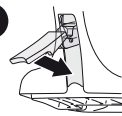

PEUGEOT 607, 4-dr Sedan, 00-

| X    |
|------|
| 27,5 |

1

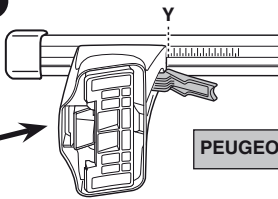

2

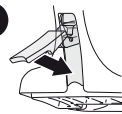

PEUGEOT 607, 4-dr Sedan, 00-

| Y  |
|----|
| 26 |



480R



480

1

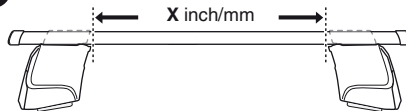

2



PEUGEOT 607, 4-dr Sedan, 00-

| X inch  | X mm   |
|---------|--------|
| 36 1/2" | 926 mm |

1

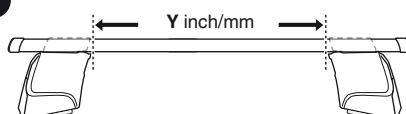

2

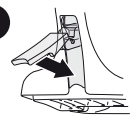

PEUGEOT 607, 4-dr Sedan, 00-

| Y inch  | Y mm   |
|---------|--------|
| 35 7/8" | 911 mm |

4

PEUGEOT 607, 4-dr Sedan, 00-

76



359



76



359

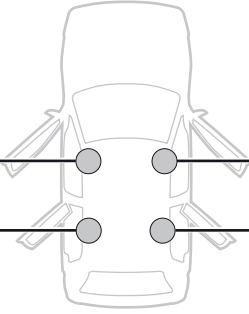

76



360



76



361

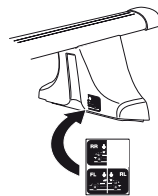
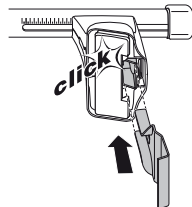
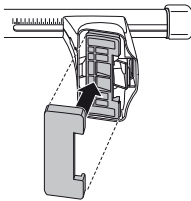
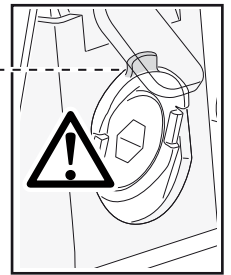
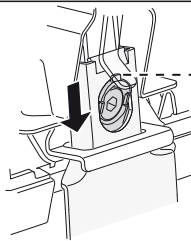
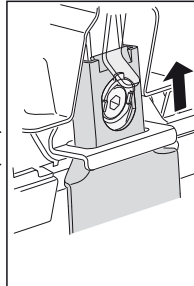
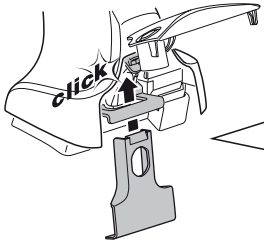
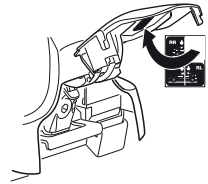
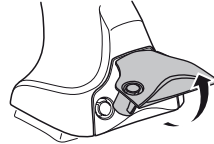
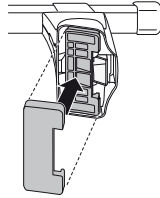
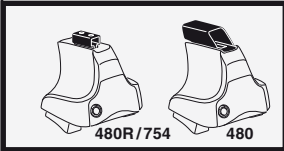

5

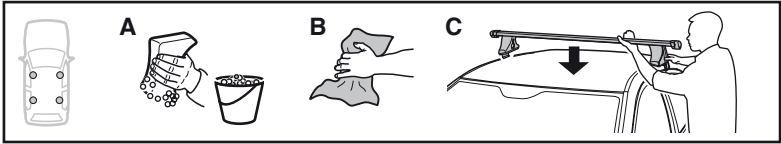

|                              | X mm   | Y mm   | X inch | Y inch   |
|------------------------------|--------|--------|--------|----------|
| PEUGEOT 607, 4-dr Sedan, 00- | 255 mm | 700 mm | 10 "   | 27 1/2 " |

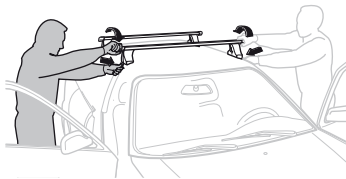
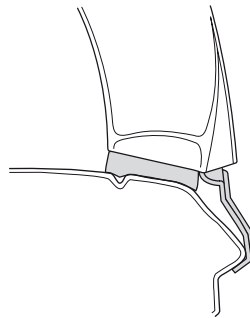
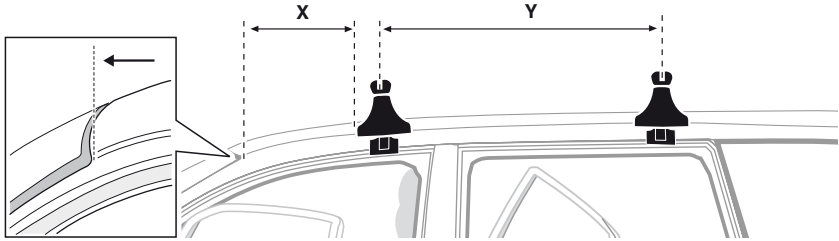

**GB/US** Tighten alternately

**D** Die Schrauben abwechselnd anziehen

**F** Serrer alternativement chaque côté

**NL** Afwisselend aan de linker- en de rechterkant aandraaien

**I** Alternare il serraggio delle viti

**E** Apertar alternativamente

**PT** Aperte alternadamente

**S** Dra åt växelvis

**FIN** Kierrä vuorotellen

**EST** Pinguldage vaheldumisi

**LAT** Pielieciet pamišus

**LIT** Užsukinėkite pakaitomis

**PL** Śruby dokręcaj naprzemiennie

**RU** Затягивайте попеременно

**CZ** Pokręťta bagażnika dokręcaj dokręcaj naprzemiennie.

**SK** Doťahujte striedavo

**SLO** Privijajte izmenično.

**HR** Naizmjenično zategnite

**HU** Egymástól függetlenül szorítandó

**GR** Σφιγγετε εναλλάξ

**TR** Dönüşümlü sıkın

**中文** 交替拧紧

**한국어** 번갈아 가며 조이십시오.

**日本語** 交互に締め付けてください。

**ไทย** ชันโนแบบสลับ

6



480R/754



480

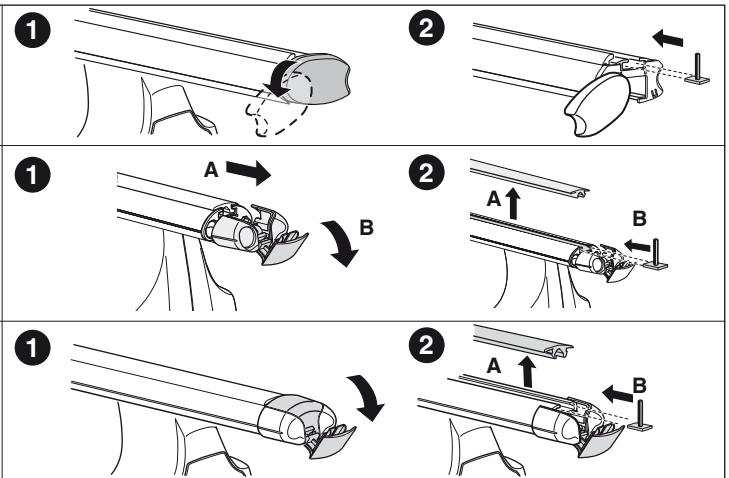
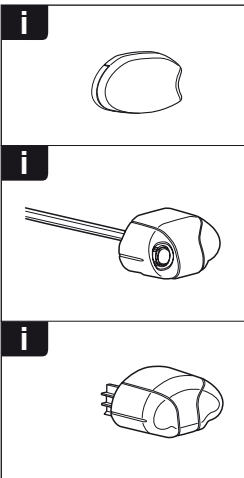
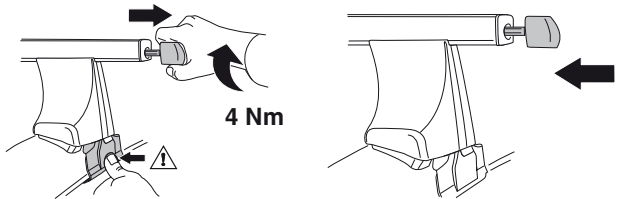
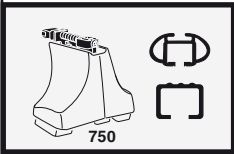
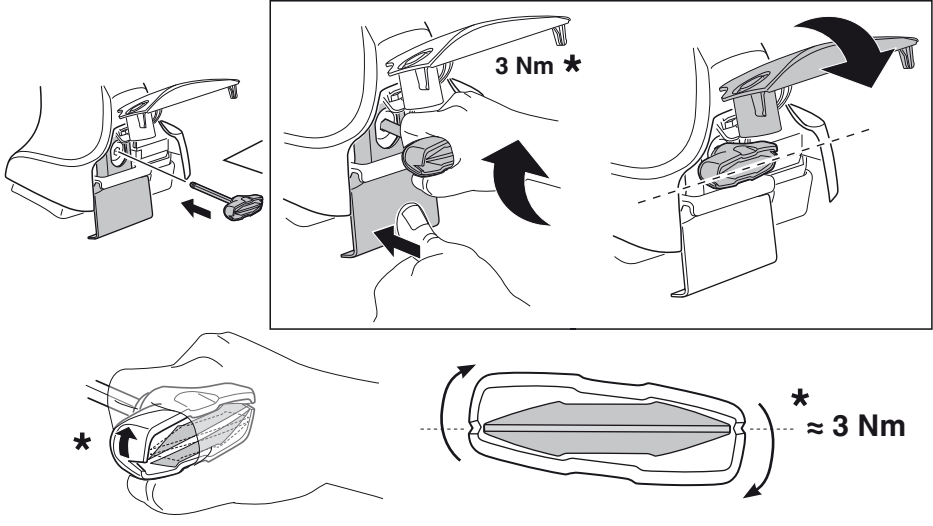

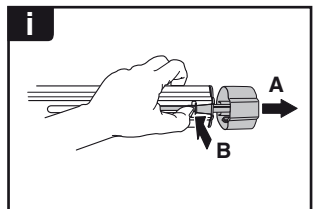
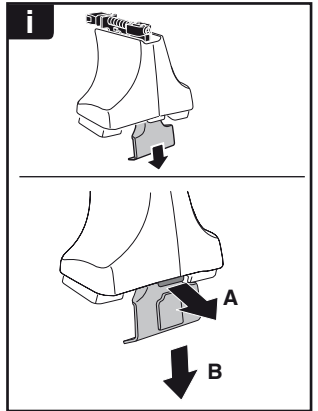
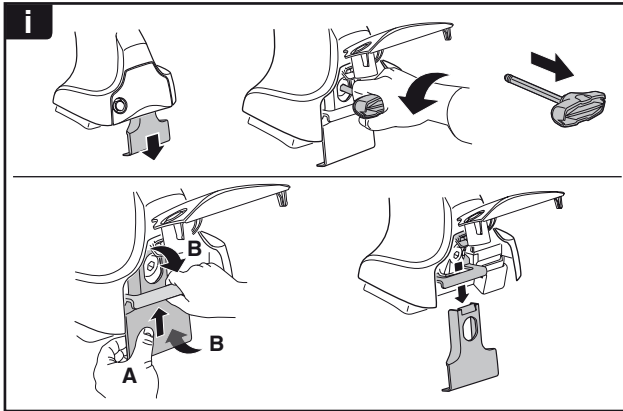
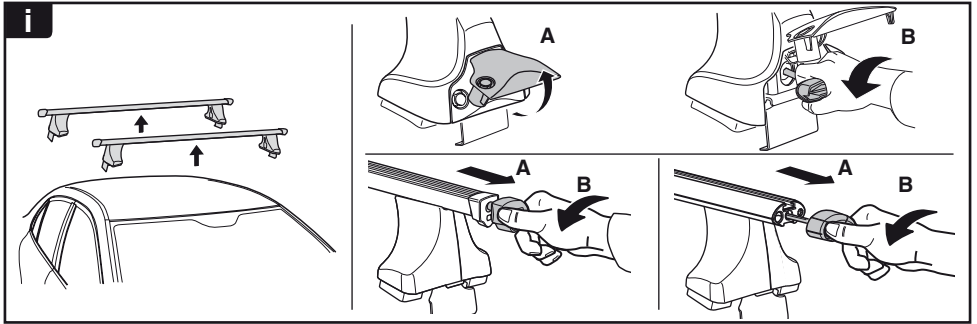

**THULE**  
SWEDEN  
**ONE  
KEY  
SYSTEM**

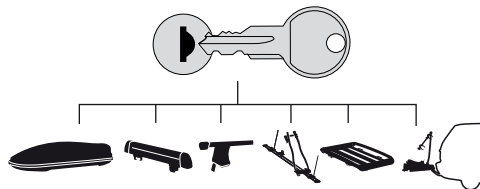

|      |  |       |
|------|--|-------|
|      |  | (x4)  |
|      |  | (x6)  |
|      |  | (x8)  |
| NA   |  | (x10) |
| EUR  |  | (x12) |
| ASIA |  | (x12) |

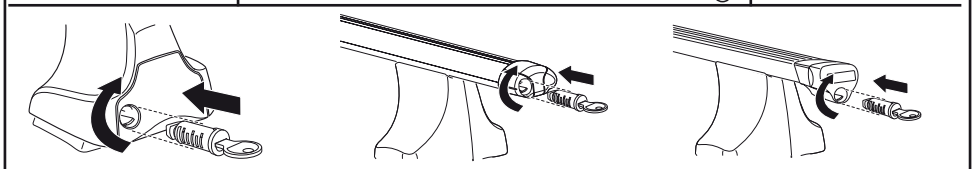

WW ▶ Thule Sweden AB, Box 69, 330 33 Hillerstorp, SWEDEN  
NA ▶ Thule Inc., 42 Silvermine Road, Seymour, Connecticut 06483, USA

info@thule.com  
customer.service@thule.com

www.thule.com