

Kit 1065

TOYOTA Ipsum, 5-dr MPV, 97-00

TOYOTA PicNic, 5-dr MPV, 97-00

480R
754

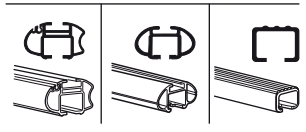
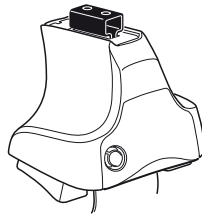

480

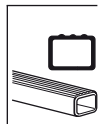
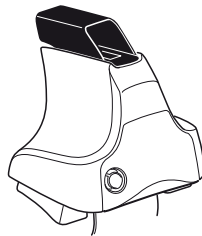

750

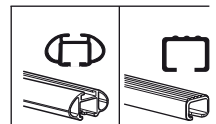
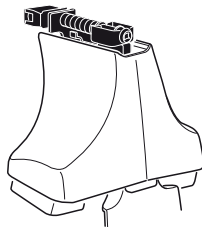

Kit



3

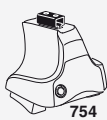

754

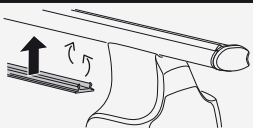
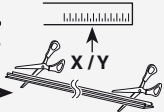

750

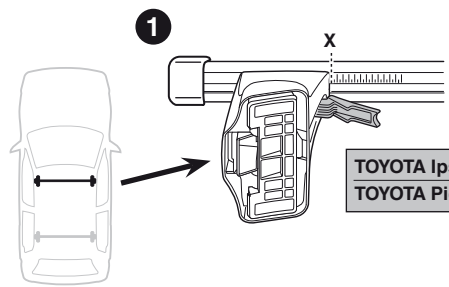

1

2

	X
TOYOTA Ipsum, 5-dr MPV, 97-00	28,5
TOYOTA PicNic, 5-dr MPV, 97-00	28,5

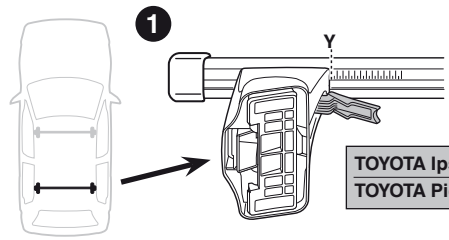

1

2

	Y
TOYOTA Ipsum, 5-dr MPV, 97-00	26
TOYOTA PicNic, 5-dr MPV, 97-00	26



480R



480

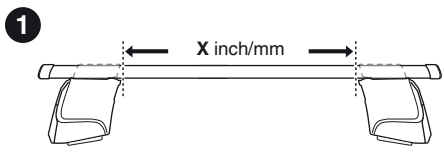

1

2

	X inch	X mm
TOYOTA Ipsum, 5-dr MPV, 97-00	36 ⁷ / ₈ "	936 mm
TOYOTA PicNic, 5-dr MPV, 97-00	36 ⁷ / ₈ "	936 mm

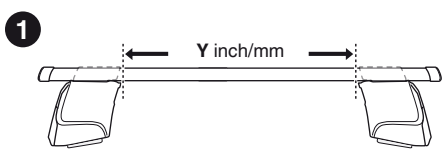
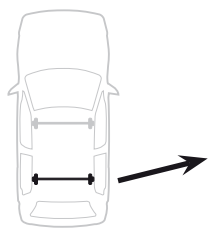
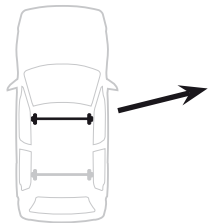

1

2

	Y inch	Y mm
TOYOTA Ipsum, 5-dr MPV, 97-00	35 ⁷ / ₈ "	911 mm
TOYOTA PicNic, 5-dr MPV, 97-00	35 ⁷ / ₈ "	911 mm

4

TOYOTA Ipsum, 5-dr MPV, 97-00
 TOYOTA PicNic, 5-dr MPV, 97-00

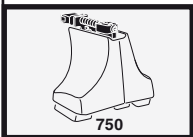
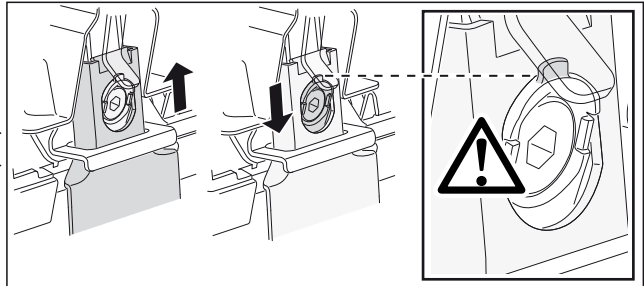
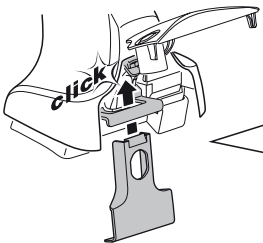
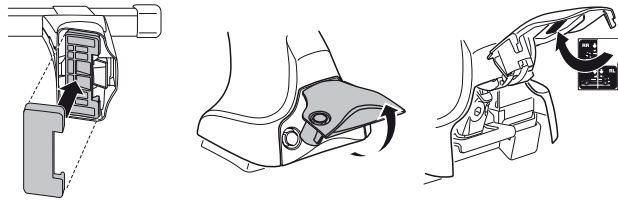
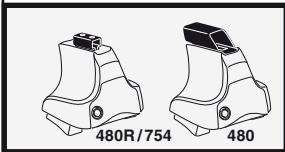
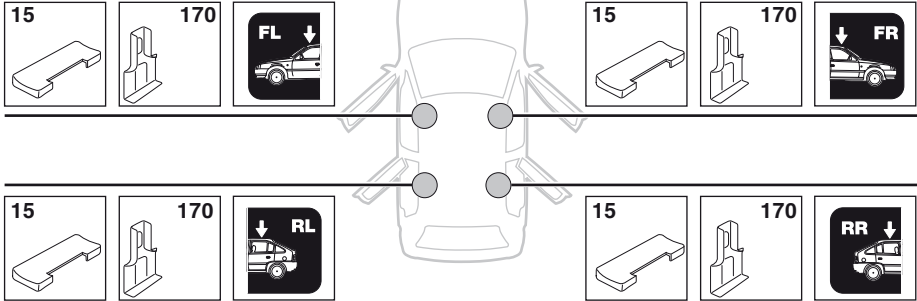

5



	X mm	Y mm	X inch	Y inch
TOYOTA Ipsum, 5-dr MPV, 97-00	400 mm	700 mm	15 3/4"	27 1/2"
TOYOTA PicNic, 5-dr MPV, 97-00	400 mm	700 mm	15 3/4"	27 1/2"

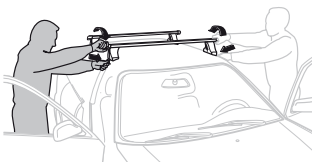
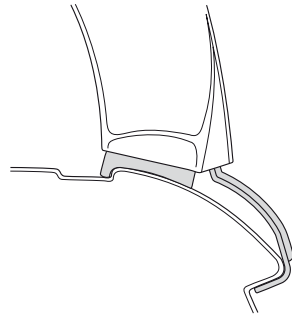
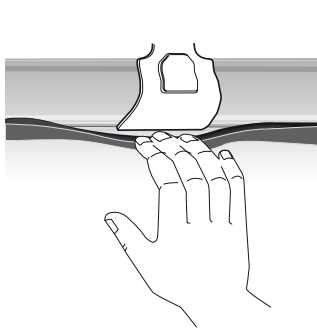
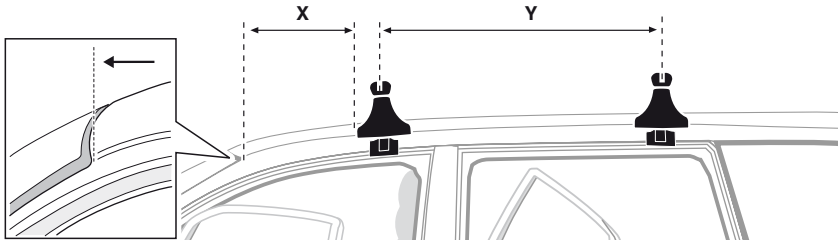

GB/US

Tighten alternately

D

Die Schrauben abwechselnd anziehen

F

Serrer alternativement chaque côté

NL

Afwisselend aan de linker- en de rechterkant aandraaien

I

Alternare il serraggio delle viti

E

Apertar alternativamente

PT

Aperte alternadamente

S

Dra åt växelvis

FIN

Kierrä vuorotellen

EST

Pinguldage vaheldumisi

LAT

Pievēciēt pamišus

LIT

Užsukinėkite pakaitomis

PL

Śruby dokręcaj naprzemiennie

RU

Затягивайте попеременно

CZ

Pokręťta багаžníka dokręcaj dokręcaj naprzemiennie.

SK

Dotiahujte striedavo

SLO

Privijajte izmenično.

HR

Naizmjenično zategnite

HU

Egymástól fűggetlenül szorítandó

GR

Σφιγγετε εναλάξ

TR

Dönüşümlü sıkın

中文

交替拧紧

한국어

번갈아 가며 조이십시오.

日本語

交互に締め付けてください。

ไทย

ขันในแบบสลับ

6



480R/754



480

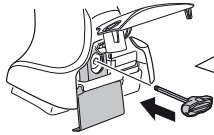

*
3 Nm



*



*
≈ 3 Nm

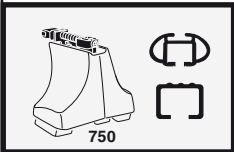
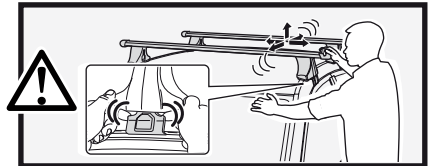

750

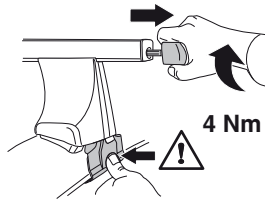

4 Nm

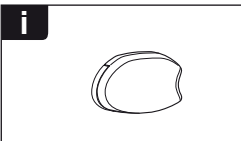
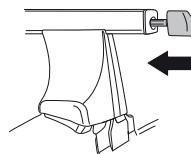

i

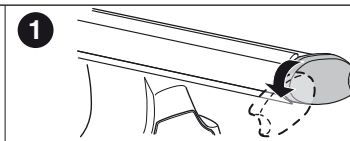

1

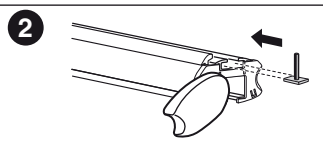

2

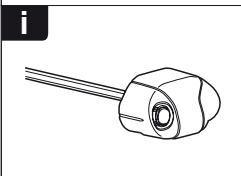

i

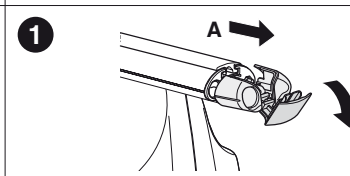

1

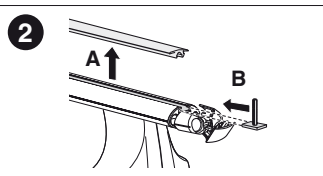

2

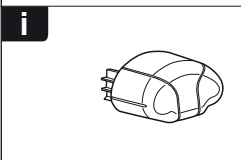

i

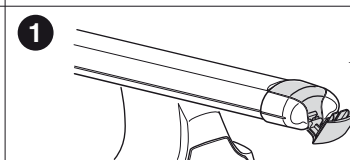

1

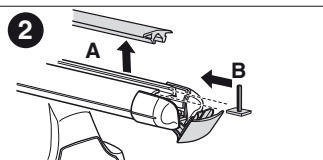

2



THULE
SWEDEN
**ONE
KEY
SYSTEM**



- 544 (x4)
- 596 (x6)
- 588 (x8)
- NA 510 (x10)
- EUR 452 (x12)
- ASIA



WW ▶ Thule Sweden AB, Box 69, 330 33 Hillerstorp, SWEDEN
NA ▶ Thule Inc., 42 Silvermine Road, Seymour, Connecticut 06483, USA

info@thule.com
customer.service@thule.com

www.thule.com