

Thule Sprint XT 569

➤ Instructions

**CITY CRASH**

Complies with ISO norm



WingBar

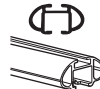

AeroBar



SlideBar



ProBar

569001C.20160615
501-7906-03

EN Roof-mounted bike carrier
DE Dachfahrradträger
FR Porte-vélo sur le toit
NL Fietsdrager voor op het dak
IT Portabici da installare sul tetto
ES Portabicicletas de techo
PT Suporte para bicicleta para teto
SV Takmonterad cykelhållare
DK Tagmonteret cykelholder
NO Takmonterte lasteholdere
FI Katolle asennettava polkupyöräteline
ET Katusele paigaldatav jalgrattahoidik
LV Uz jumta uzstādāms velosipēdu turētājs
LT Ant stogo tvirtinami dviračių laikikliai
PL Bagażnik rowerowy montowany na dachu
RU Устанавливаемое на крыше крепление для велосипедов

UK Багажник для велосипедів, що монтується на даху
BG Покривен багажник за велосипеди
CS Nosič jízdních kol s montáží na střechu
SK Nosič bicyklov s montážou na strechu
SL Nosilec za kolesa
HR/BiH Krovni nosač bicikla
RO Suport pentru bicicletă montat pe pavilion
HU Tetőre szerelhető kerékpártartó
EL Σχήμα ποδηλάτου οροφής
TR Araç üstüne bağlanan bisiklet taşıyıcı
HE מושב אופניים על הגג
AR حامل الدراجة للتثبيت على السقف
ZH 頂置自行車架
JA ルーフマウント型サイクルキャリア
KO 지붕 장착 자전거 캐리어
TH โคร่งยึดจับจักรยานแบบติดตั้งบนหลังคา

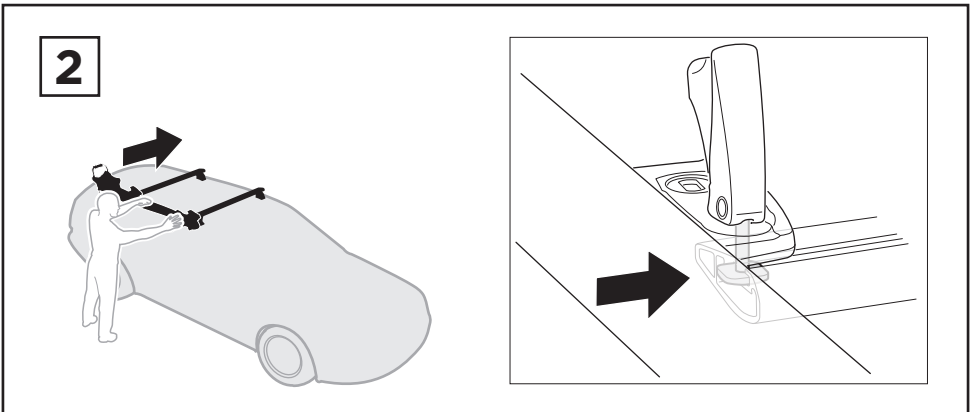
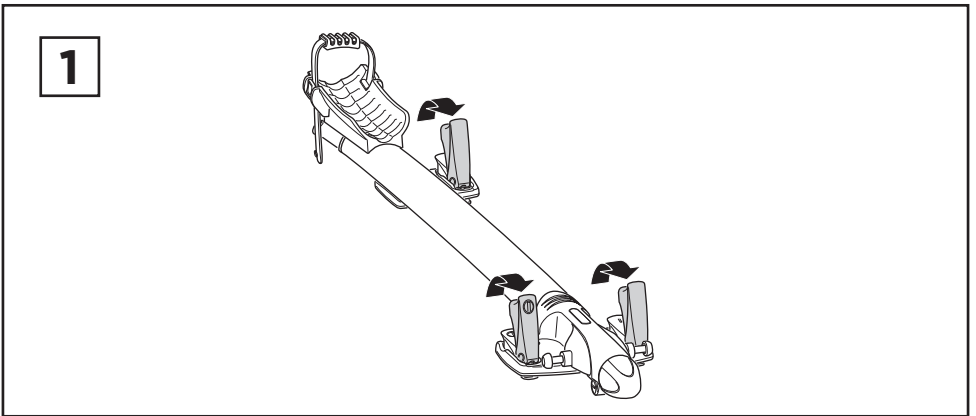
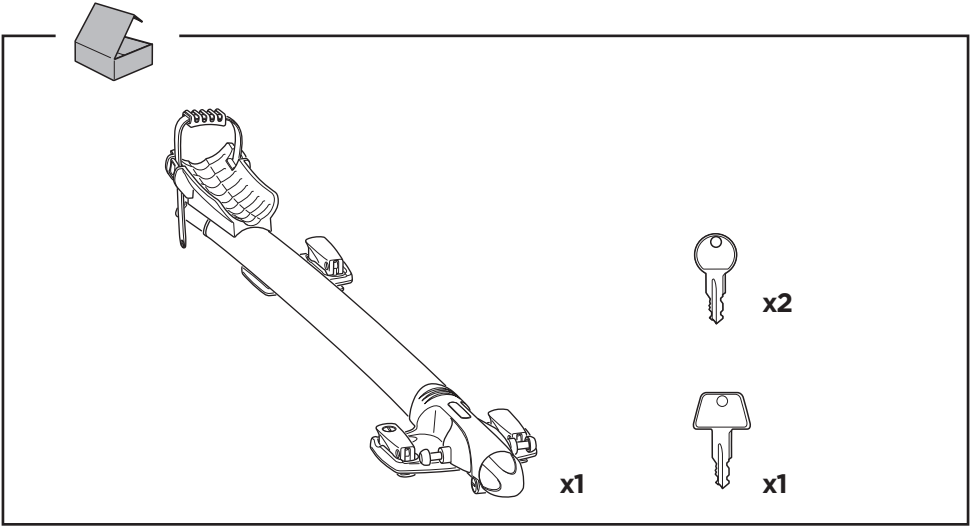

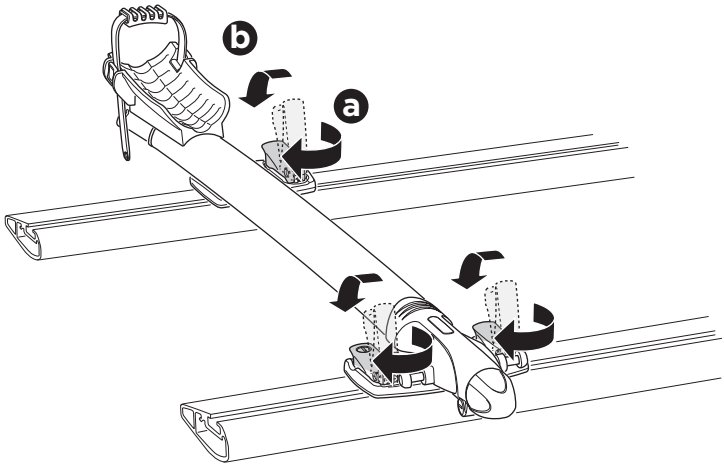
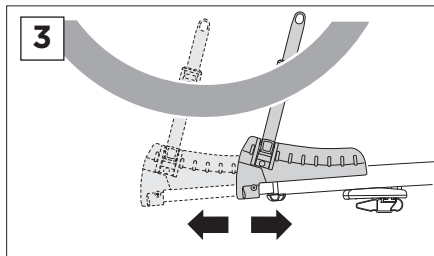
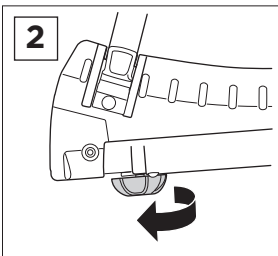
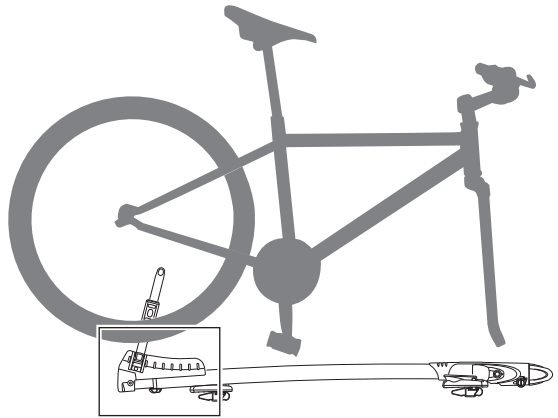
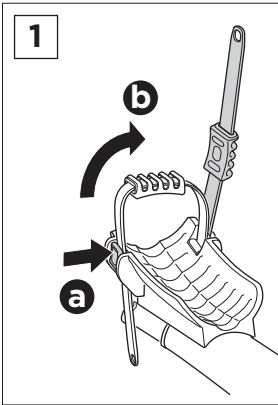
3**4**

5



2

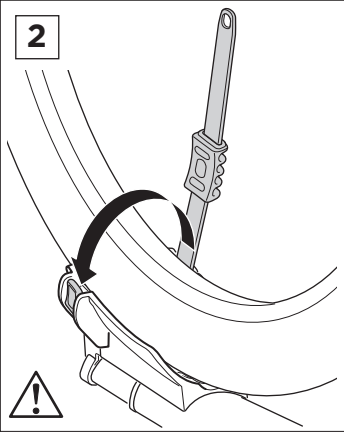

3

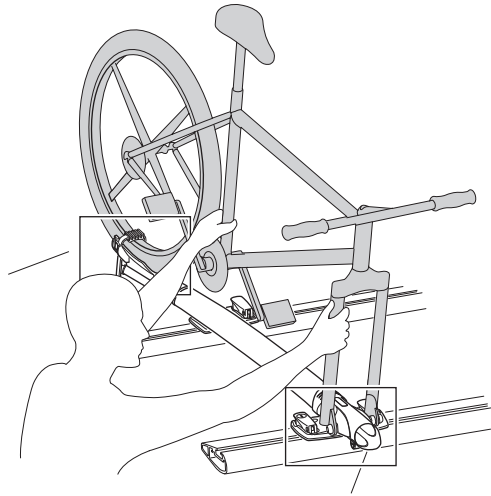
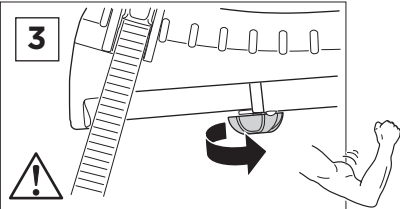

1

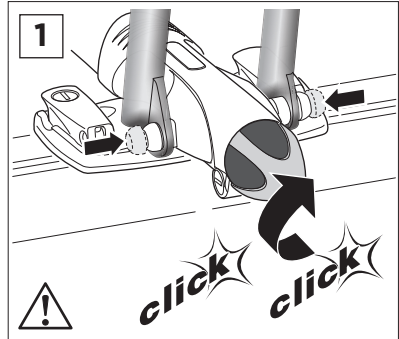

6

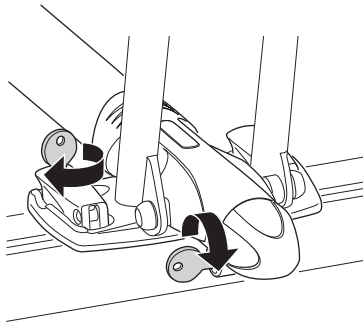

EN Left-hand fitting	BG Монтаж отляво
DE Montage links	CS Montáž z levé strany
FR Montage côté gauche	SK Montáž na ľavej strane
NL Montage aan de linker kant	SL Pritrjevanje z leve strani
IT Montaggio a sinistra	HR/BIH Montaža s lijeve strane
ES Montaje a izquierda	RO Montare pe partea stângă
PT Montagem do lado esquerdo	HU Bal oldalról szerelhető
SV Vänstermonterad	EL Τοποθέτηση αριστερά
DK Venstremontering	TR Sol elle montaj
NO Venstremontering	التركيب في الجانب الأيسر AR
FI Asennus vasemmalle	תהקנה שמאלית HE
ET Vasakpoolne kinnitamine	ZH 从左侧安装
LV Kreisais stiprinājums	JA 左手装着
LT Kairysis pritvirtinimas	KO 왼손 장착
PL Montaż z lewej	TH ตัวยึดด้านซ้ายมือ
RU Установка на левую сторону	
UK Установка на ліву сторону	

i

x1

x1

1

a

b

2

a

b

c

i

1

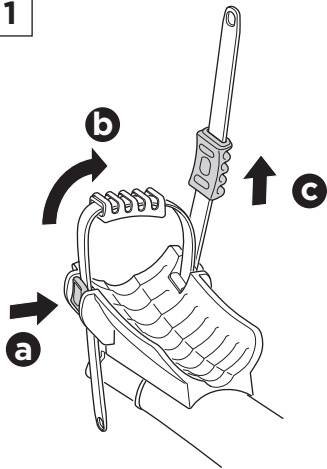

2

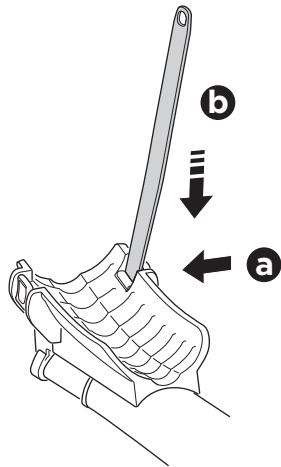

3

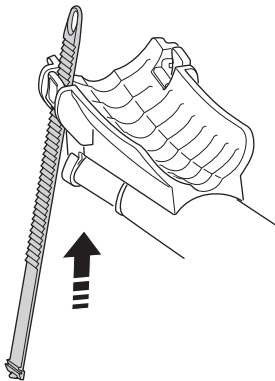

4

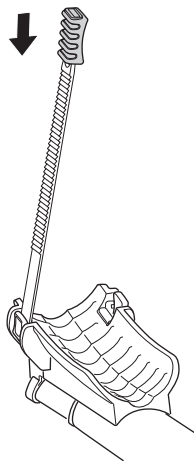

EN Accessories
DE Zubehör
FR Accessoires
NL Accessoires
IT Accessori
ES Accesorios
PT Acessórios
SV Tillbehör
DK Tilbehør
NO Tilbehør
FI Lisävarusteet
ET Lisavarustus
LV Piederumi
LT Priedai
PL Akcesoria
RU Аксессуары

UK Аксессуары
BG Принадлежности
CS Dopřloky
SK Príslušenstvo
SL Dodatki
HR/BiH Dodaci
RO Accesorii
HU Tartozékok
EL Εξαρτήματα
TR Aksesuarlar

AR الملحقا
 HE אביזרים

ZH 附件
JA アクセサリー
KO 액세서리
TH อุปกรณ์เสริม

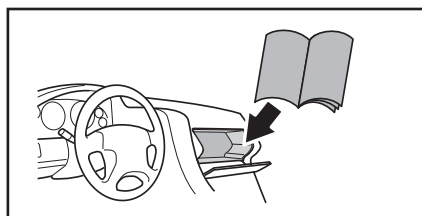
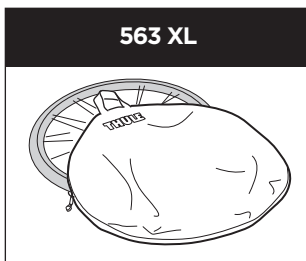
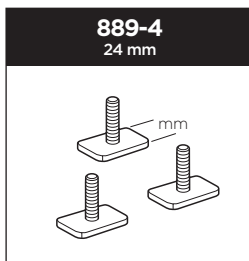
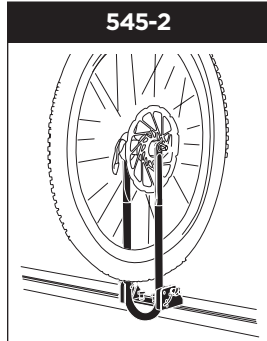

Thule One-Key System

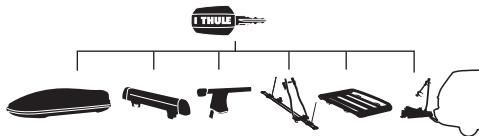

544  (x4)
596  (x6)
588  (x8)
452  (x12)